

Quadrus Bold

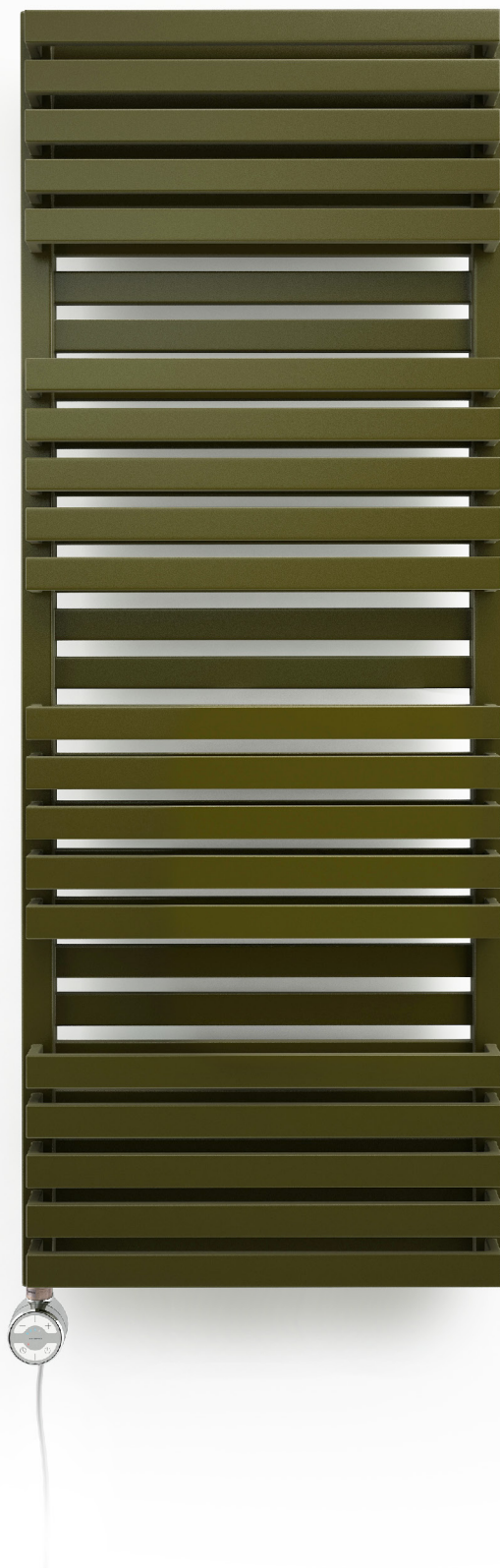

Colour included
in the price



Quadrus Bold 1185 x 450
colour: RAL 6003

MOA heating element, chrome

Quadrus Bold



Colour included in the price

design: Terma

Connections:

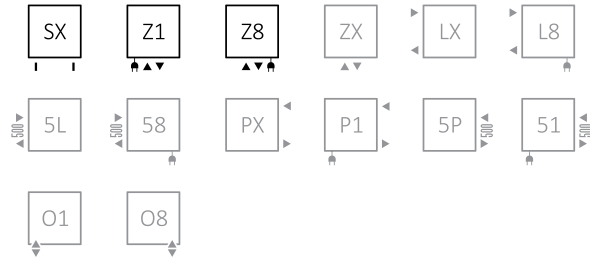

Electric radiators:

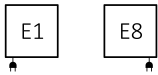

Available sizes:

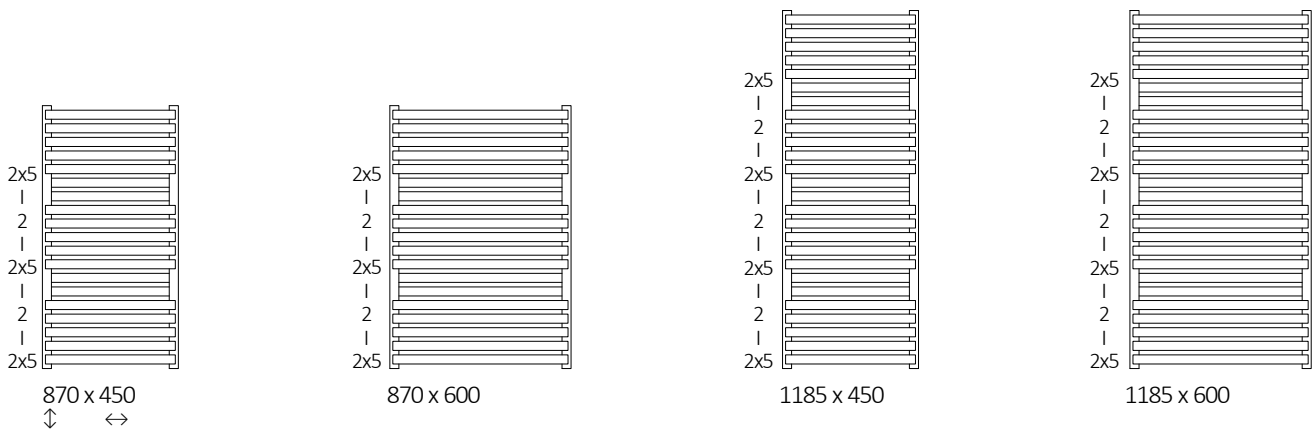

We recommend:

A set of integrated thermostatic valves for Z1 and Z8 connections



Integrated pipe-masking set





KTX 2 heating element



Specifications:

Working pressure: 1,0 MPa Maximum operating temperature: 95°C

A ↓	B ↔	C1 [mm]	C2 [mm]	75/65/20°C [W]	55/45/20°C [W]	 [W]	D [mm]	E [mm]	F [mm]	 [dm³]	 [kg]	Product Code Configuration codes.<?>
870	450	50	420	531	285	600	420	690	90	4,11	15,16	WGQBA087045
870	600	50	570	708	380	800	570	690	90	5,08	19,54	WGQBA087060
1185	450	50	420	835	446	800	420	1005	90	5,57	20,50	WGQBA118045
1185	600	50	570	1113	594	1000	570	1005	90	6,88	26,43	WGQBA118060

Quadrus Bold



Colour included in the price

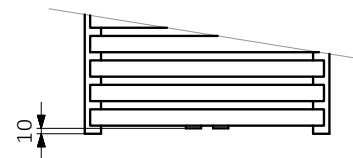
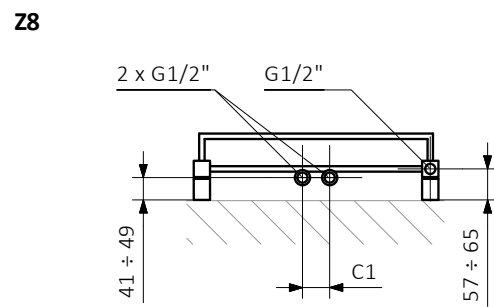
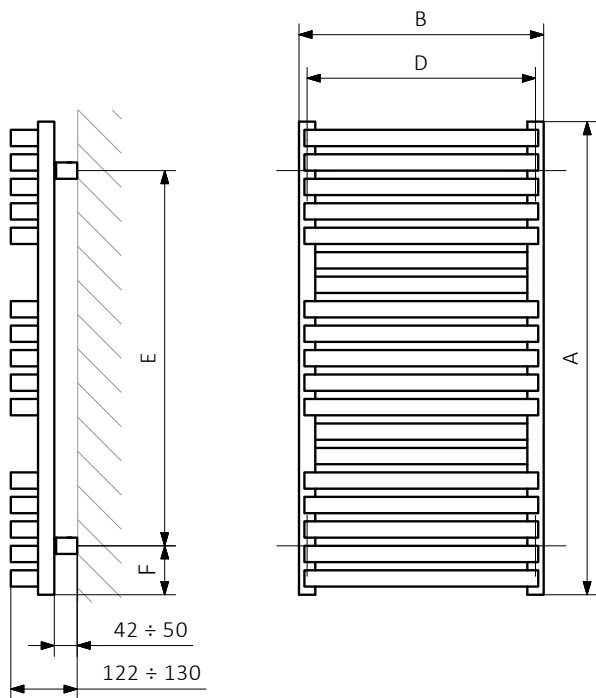
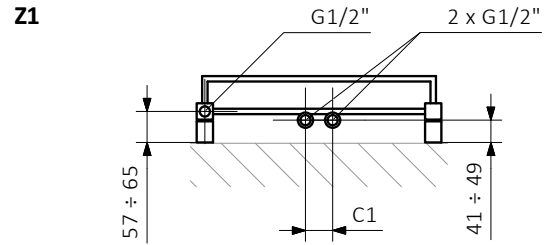
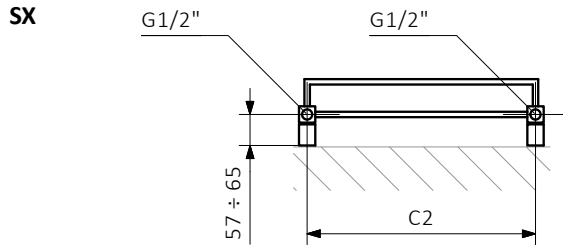

A — Height B — Width C1-C5 — Distance between pipe centres D — Horizontal distance between mounting bracket centres
E — Vertical distance between mounting brackets F — Distance between a mounting bracket and the bottom of the radiator

Collector:

Profile:

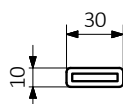
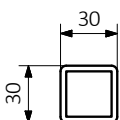

Quadrus Bold



Colour included
in the price

Product codes can be found in product data sheet tables. The codes provide some basic information about the product while a partially filled configuration code contains complementary information about the detailed specifications. When placing an order, product codes should include the fully completed configuration part. The configuration code part should be placed after the main product code. The main product code and configuration part will appear as shown in the example below:

The construction of a water and dual fuel radiator product and configuration code:

WGALE054030

K916SX

PRODUCT CODE
(located in the table for the product)

CONFIGURATION CODE
(supplemented by hand)

Configuration

K 916 SX

Package code Colour code Connection code
K – carton box

Construction of electric heater configuration code

WLALE054030

K916E1DRYM

PRODUCT CODE
(located in the table for the product)

CONFIGURATION CODE
(supplemented by hand)

Configuration

K 916 E1 DRY M

Package code Colour code Connection code Heating element code Type of heating element cable code
K – carton box

Zinc powder primer

C – Code of zinc powder primer is an extra processes

WLALE054030 K916SX **C** – Extra processes or additions code

Quadrus Bold



Colour included
in the price

Legend



Available in chrome finish.



Radiator available in a “water” version.



Radiator suitable for dual fuel connection. Electric heating element can be installed.



Radiator available in electric only version. It comes prefilled with a ‘heating medium’ and equipped with a heating element. All tested and ready to use.



Connection types dedicated for this radiator.
The icon shows the flow and return connections for the radiator as well as the thermostatic valve and heating element position if applicable.



Optional connections available for this radiator.



Suggested heating element power output for electric and dual fuel versions.



Weight.



Capacity.